

Thermally-Enhanced High Power RF LDMOS FETs 120 W, 920 – 960 MHz

Description

The PTFA091201GL and PTFA091201HL are 120-watt LDMOS FETs designed for ultra-linear GSM/EDGE power amplifier applications in the 920 to 960 MHz band. Features include input and output matching, and thermally-enhanced plastic open-cavity packages with copper flanges. Manufactured with Infineon's advanced LDMOS process, these devices provide excellent thermal performance and superior reliability.

PTFA091201GL
Package PG-63248-2

PTFA091201HL
Package PG-64248-2

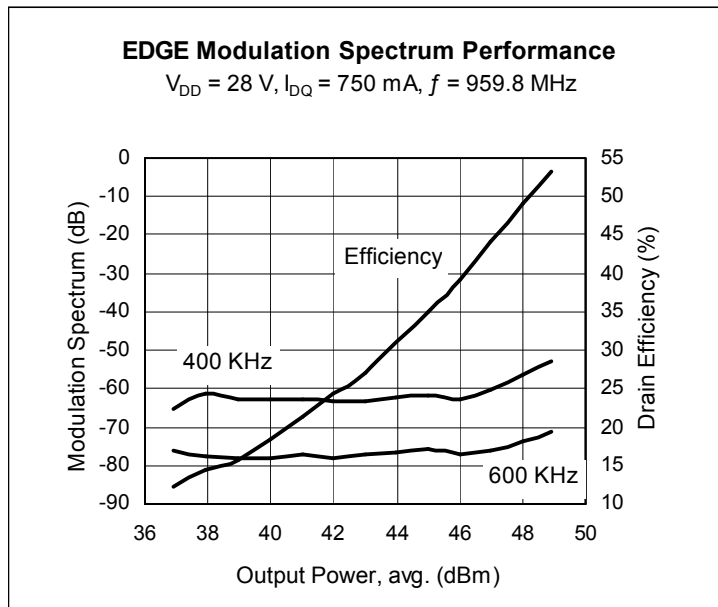
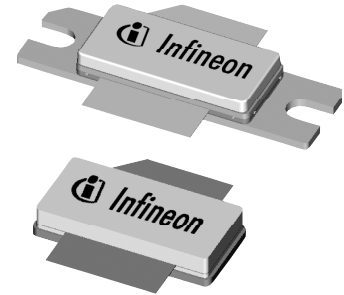

Features

- Thermally-enhanced plastic open-cavity (EPOC™) packages with copper flanges, Pb-free and RoHS compliant
- Broadband internal matching
- Typical EDGE performance
 - Average output power = 50 W
 - Gain = 18.5 dB
 - Efficiency = 44%
- Typical CW performance
 - Output power at P-1dB = 135 W
 - Gain = 17 dB
 - Efficiency = 64%
- Integrated ESD protection: Human Body Model, Class 2 (minimum)
- Excellent thermal stability, low HCI drift
- Capable of handling 10:1 VSWR @ 28 V, 120 W (CW) output power

RF Characteristics

EDGE Measurements (not subject to production test—verified by design/characterization in Infineon test fixture)

$V_{DD} = 28\text{ V}$, $I_{DQ} = 750\text{ mA}$, $P_{OUT} = 50\text{ W (AVG)}$, $f = 959.8\text{ MHz}$

Characteristic	Symbol	Min	Typ	Max	Unit
Error Vector Magnitude	EVM (RMS)	—	2.5	—	%
Modulation Spectrum @ 400 kHz	ACPR	—	-60	—	dBc
Modulation Spectrum @ 600 kHz	ACPR	—	-74	—	dBc
Gain	G_{ps}	—	18.5	—	dB
Drain Efficiency	η_D	—	44	—	%

All published data at $T_{CASE} = 25^\circ\text{C}$ unless otherwise indicated

ESD: Electrostatic discharge sensitive device—observe handling precautions!

RF Characteristics (cont.)

Two-tone Measurements (tested in Infineon test fixture)

$V_{DD} = 28\text{ V}$, $I_{DQ} = 750\text{ mA}$, $P_{OUT} = 110\text{ W PEP}$, $f = 960\text{ MHz}$, tone spacing = 1 MHz

Characteristic	Symbol	Min	Typ	Max	Unit
Gain	G_{ps}	18.0	18.5	—	dB
Drain Efficiency	η_D	45	48	—	%
Intermodulation Distortion	IMD	—	-28	-26	dBc

DC Characteristics

Characteristic	Conditions	Symbol	Min	Typ	Max	Unit
Drain-Source Breakdown Voltage	$V_{GS} = 0\text{ V}$, $I_{DS} = 10\text{ mA}$	$V_{(BR)DSS}$	65	—	—	V
Drain Leakage Current	$V_{DS} = 28\text{ V}$, $V_{GS} = 0\text{ V}$	I_{DSS}	—	—	1.0	μA
	$V_{DS} = 63\text{ V}$, $V_{GS} = 0\text{ V}$	I_{DSS}	—	—	10.0	μA
On-State Resistance	$V_{GS} = 10\text{ V}$, $V_{DS} = 0.1\text{ V}$	$R_{DS(on)}$	—	0.07	—	Ω
Operating Gate Voltage	$V_{DS} = 28\text{ V}$, $I_{DQ} = 750\text{ mA}$	V_{GS}	2.0	2.5	3.0	V
Gate Leakage Current	$V_{GS} = 10\text{ V}$, $V_{DS} = 0\text{ V}$	I_{GSS}	—	—	1.0	μA

Maximum Ratings

Parameter	Symbol	Value	Unit
Drain-Source Voltage	V_{DSS}	65	V
Gate-Source Voltage	V_{GS}	-0.5 to +12	V
Junction Temperature	T_J	200	$^{\circ}\text{C}$
Total Device Dissipation	P_D	625	W
		Above 25 $^{\circ}\text{C}$ derate by	3.57
Storage Temperature Range	T_{STG}	-40 to +150	$^{\circ}\text{C}$
Thermal Resistance ($T_{CASE} = 70^{\circ}\text{C}$, 120 W CW, soldered)	$R_{\theta JC}$	0.28	$^{\circ}\text{C/W}$

Ordering Information

Type and Version	Package	Package Description	Shipping	Marking
PTFA091201GL V1	PG-63248-2	Thermally-enhanced slotted flange, single-ended	Tray	PTFA091201GL
PTFA091201HL V1	PG-64248-2	Thermally-enhanced earless flange, single-ended	Tray	PTFA091201HL

Typical Performance (data taken in a production test fixture)

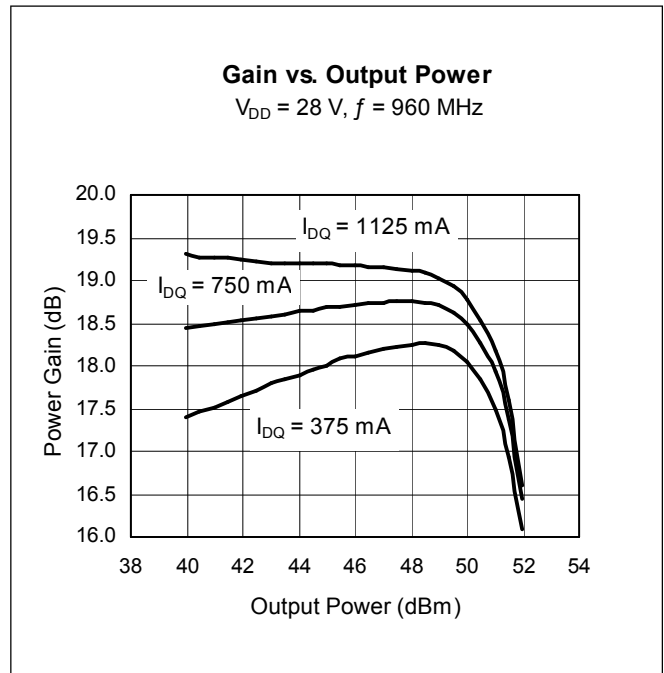
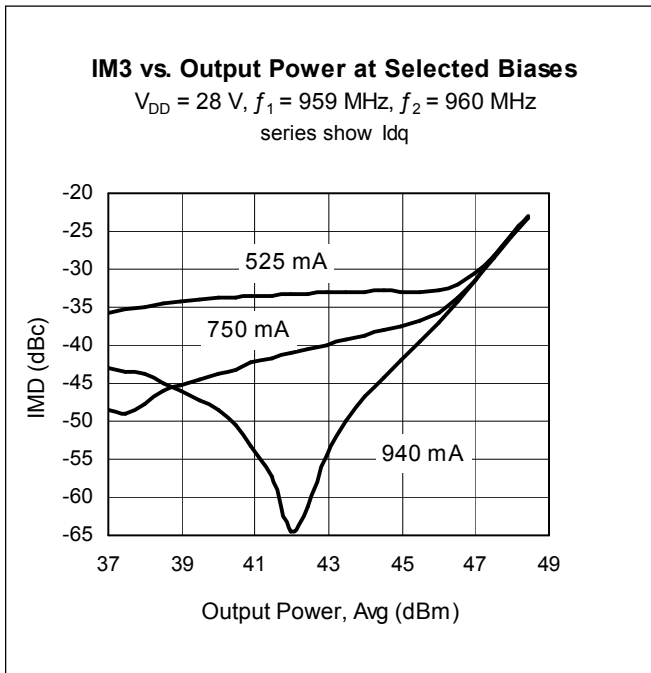
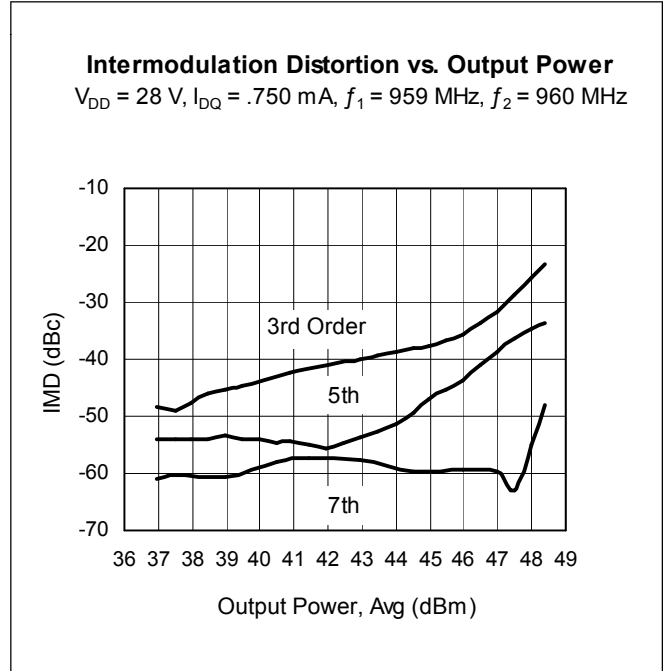
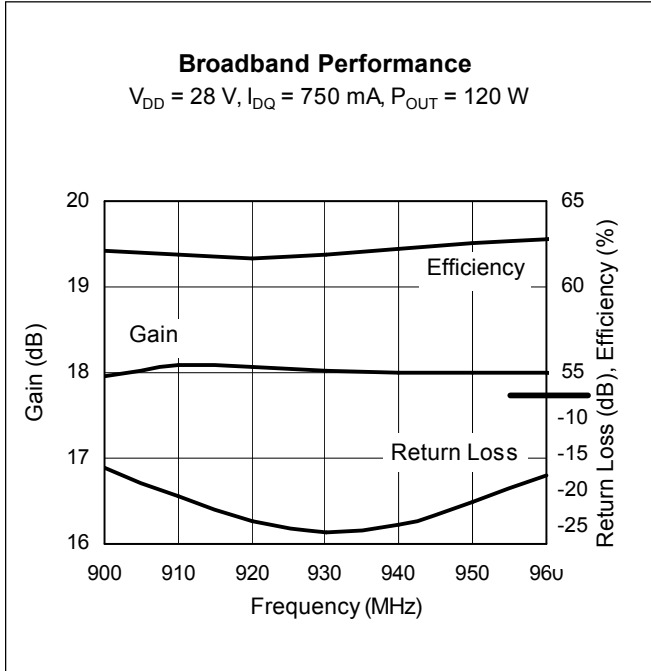

Typical Performance (cont.)

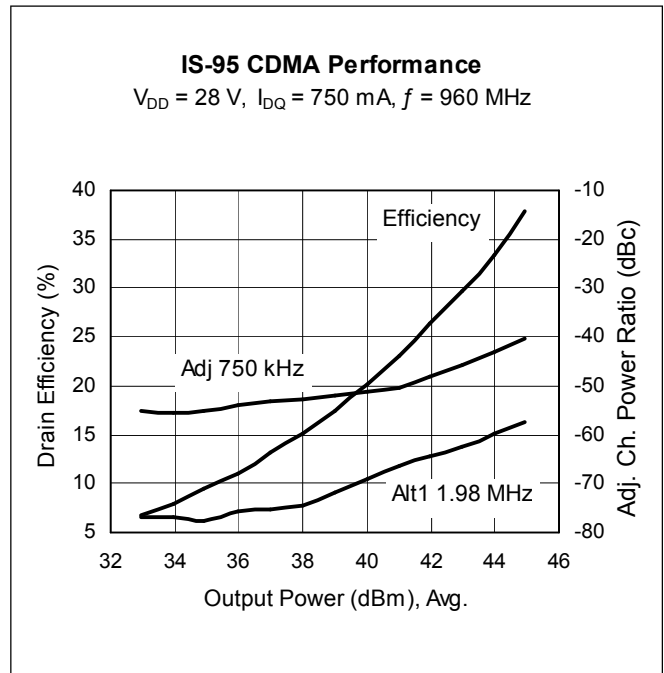
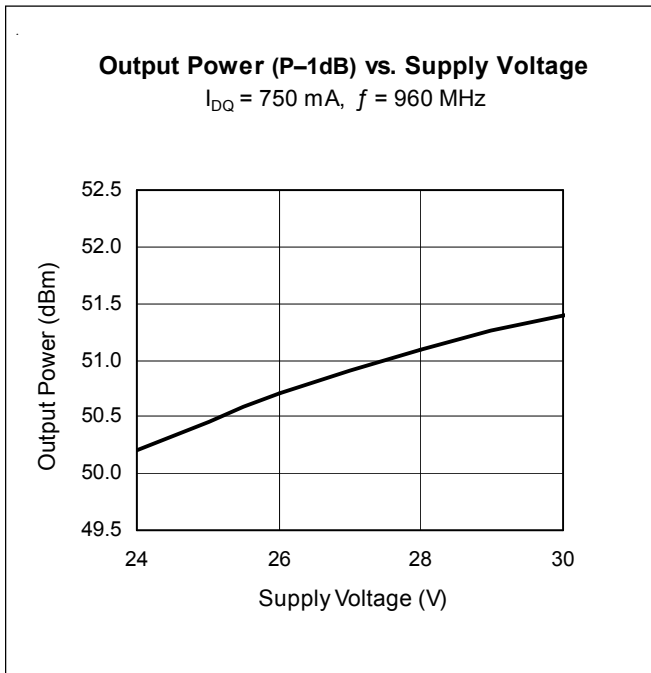
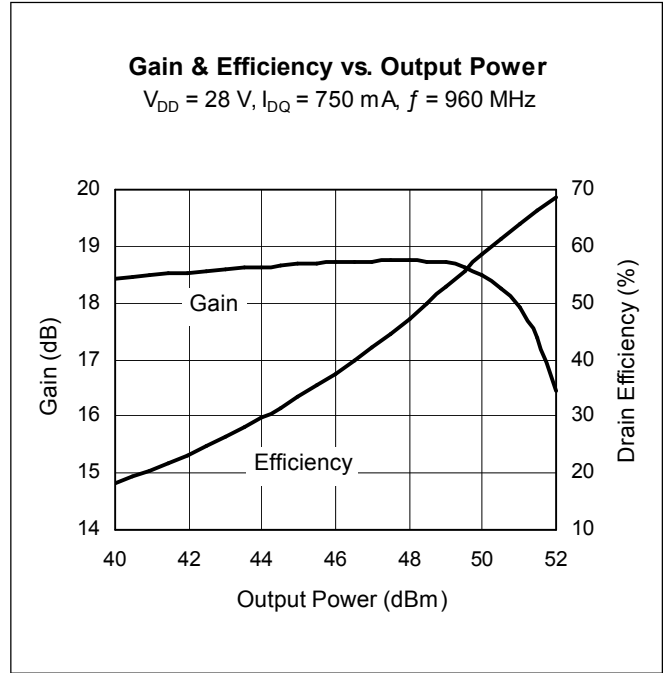
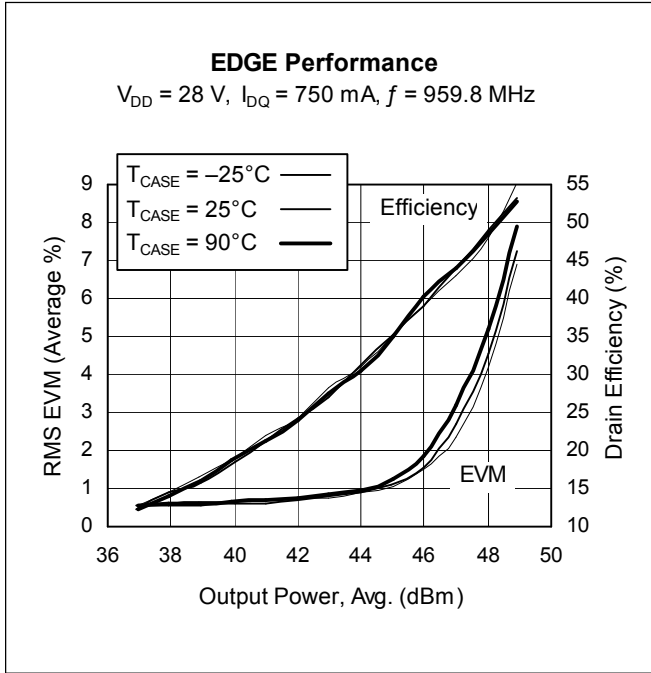

Typical Performance (cont.)

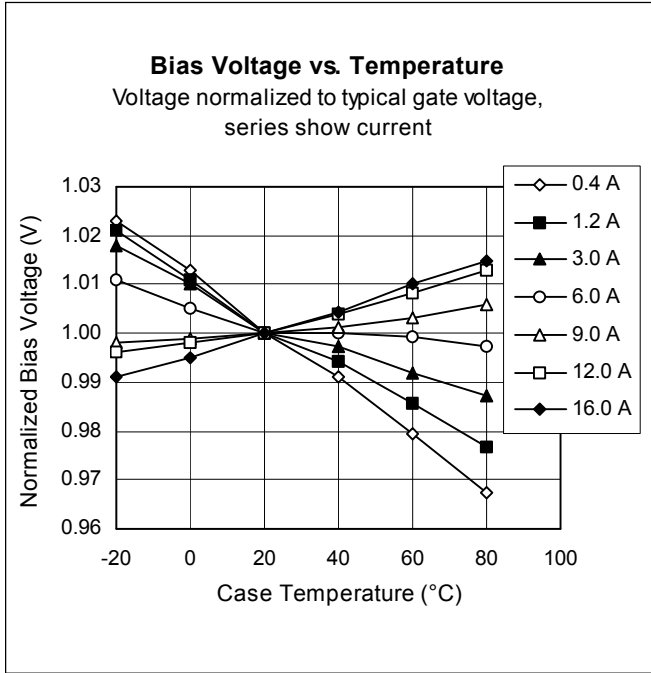

Broadband Circuit Impedance

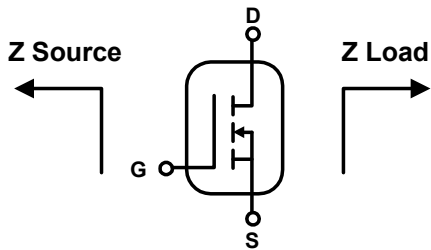

Frequency MHz	Z Source W		Z Load W	
	R	jX	R	jX
920	5.86	-0.32	2.20	0.69
930	5.84	-0.27	2.17	0.69
940	5.85	-0.02	2.16	0.85
950	5.82	0.10	2.15	0.92
960	5.79	0.27	2.13	1.02

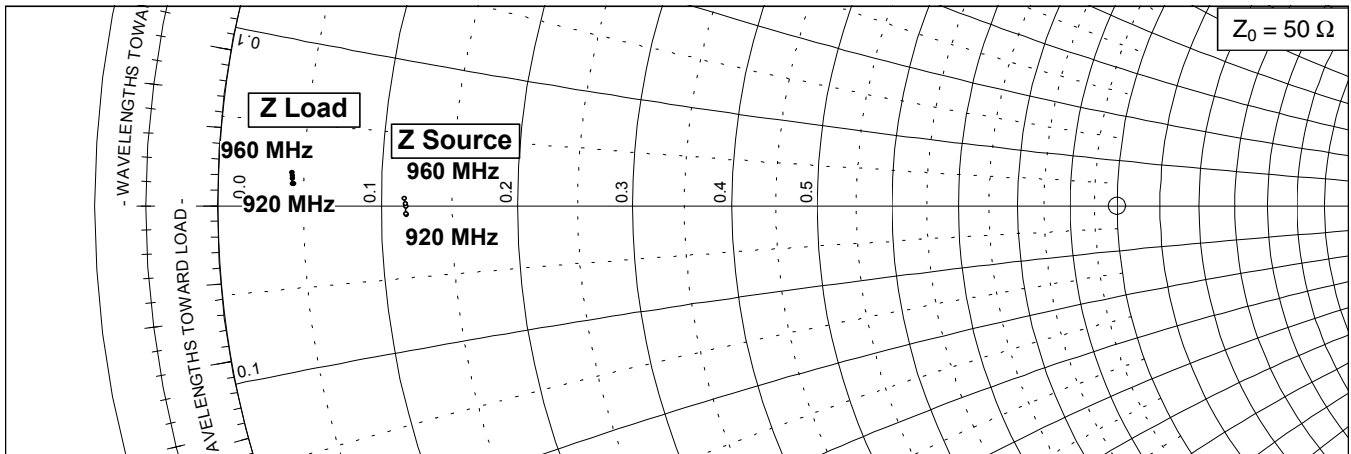

Reference Circuit

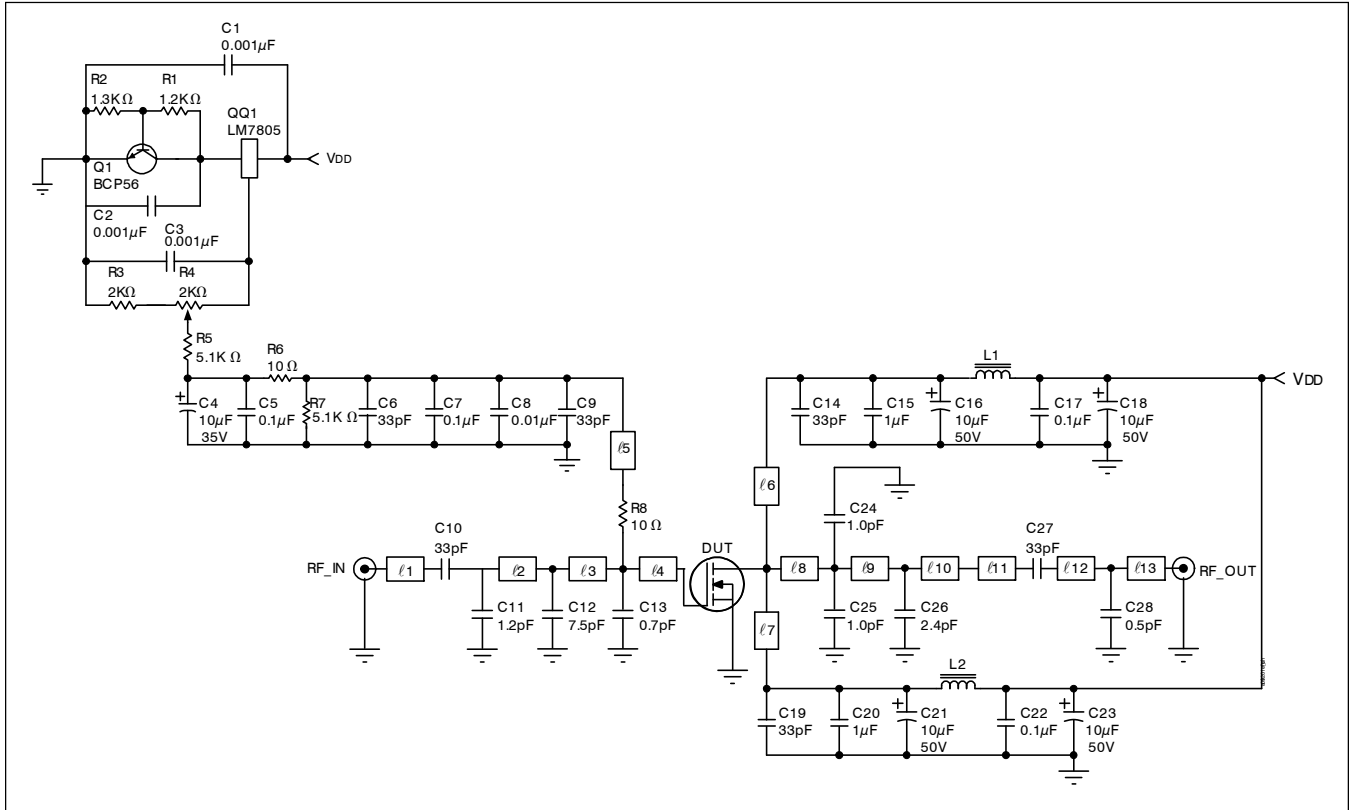

Reference circuit schematic for $f = 960 \text{ MHz}$

Circuit Assembly Information

DUT	PTFA091201GL or PTFA091201HL		LDMOS Transistor
PCB	0.76 mm [.030"] thick, $\epsilon_r = 4.5$	Rogers TMM4	2 oz. copper

Microstrip	Electrical Characteristics at 960 MHz ¹	Dimensions: L x W (mm)	Dimensions: L x W (in.)
l_1	0.072λ , 50.0 Ω	12.27 x 1.40	0.483 x 0.055
l_2	0.115λ , 50.0 Ω	19.53 x 1.40	0.769 x 0.055
l_3	0.029λ , 50.0 Ω	5.08 x 1.40	0.200 x 0.055
l_4	0.062λ , 7.5 Ω	9.53 x 16.15	0.375 x 0.636
l_5	0.149λ , 70.0 Ω	26.31 x 0.71	1.036 x 0.028
l_6, l_7	0.122λ , 55.0 Ω	20.96 x 1.17	0.825 x 0.046
l_8	0.027λ , 7.9 Ω	4.06 x 15.24	0.160 x 0.600
l_9	0.103λ , 7.9 Ω	15.75 x 15.24	0.620 x 0.600
l_{10}	0.072λ , 7.9 Ω	11.02 x 15.24	0.434 x 0.600
l_{11}	0.155λ , 38.0 Ω	25.78 x 2.13	1.015 x 0.084
l_{12}	0.013λ , 50.0 Ω	2.24 x 1.40	0.088 x 0.055
l_{13}	0.015λ , 50.0 Ω	2.59 x 1.40	0.102 x 0.055

¹Electrical characteristics are rounded.

Reference Circuit (cont.)

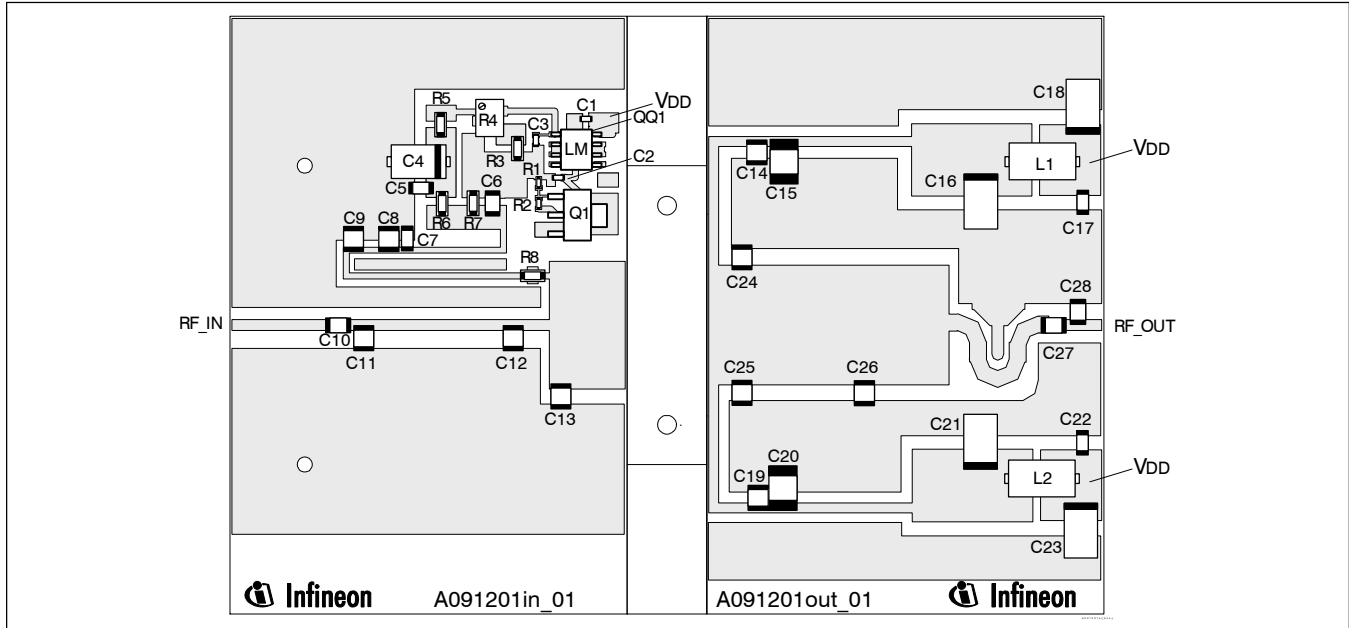

Reference circuit assembly diagram (not to scale)*

Component	Description	Suggested Manufacturer	P/N or Comment
C1, C2, C3	Capacitor, 0.001 μ F	Digi-Key	PCC1772CT-ND
C4	Tantalum capacitor, 10 μ F, 35 V	Digi-Key	399-1655-2-ND
C5, C7, C17, C22	Capacitor, 0.1 μ F	Digi-Key	PCC104BCT-ND
C6, C9, C10, C14, C19, C27	Ceramic capacitor, 33 pF	ATC	100B 330
C8	Capacitor, 0.01 μ F	ATC	200B 103
C11	Ceramic capacitor, 1.2 pF	ATC	100B 1R2
C12	Ceramic capacitor, 7.5 pF	ATC	100B 7R5
C13	Ceramic capacitor, 0.7 pF	ATC	100B 0R7
C15, C20	Capacitor, 1.0 μ F	ATC	920C105
C16, C18, C21, C23	Tantalum capacitor, 10 μ F, 50 V	Garrett Electronics	TPSE106K050R0400
C24, C25	Ceramic capacitor, 1.0 pF	ATC	100B 1R0
C26	Ceramic capacitor, 2.4 pF	ATC	100B 2R4
C28	Ceramic capacitor, 0.5 pF	ATC	100B 0R5
L1, L2	Ferrite, 8.9 mm	Elna Magnetics	BDS 4.6/3/8.9-4S2
Q1	Transistor	Infineon Technologies	BCP56
QQ1	Voltage regulator	National Semiconductor	LM7805
R1	Chip Resistor 1.2 k-ohms	Digi-Key	P1.2KGCT-ND
R2	Chip Resistor 1.3 k-ohms	Digi-Key	P1.3KGCT-ND
R3	Chip Resistor 2 k-ohms	Digi-Key	P2KECT-ND
R4	Potentiometer 2 k-ohms	Digi-Key	3224W-202ETR-ND
R5, R7	Chip Resistor 5.1 k-ohms	Digi-Key	P5.1KECT-ND
R6, R8	Chip Resistor 10 ohms	Digi-Key	P10ECT-ND

*Gerber files for this circuit available on request

Package Outline Specifications

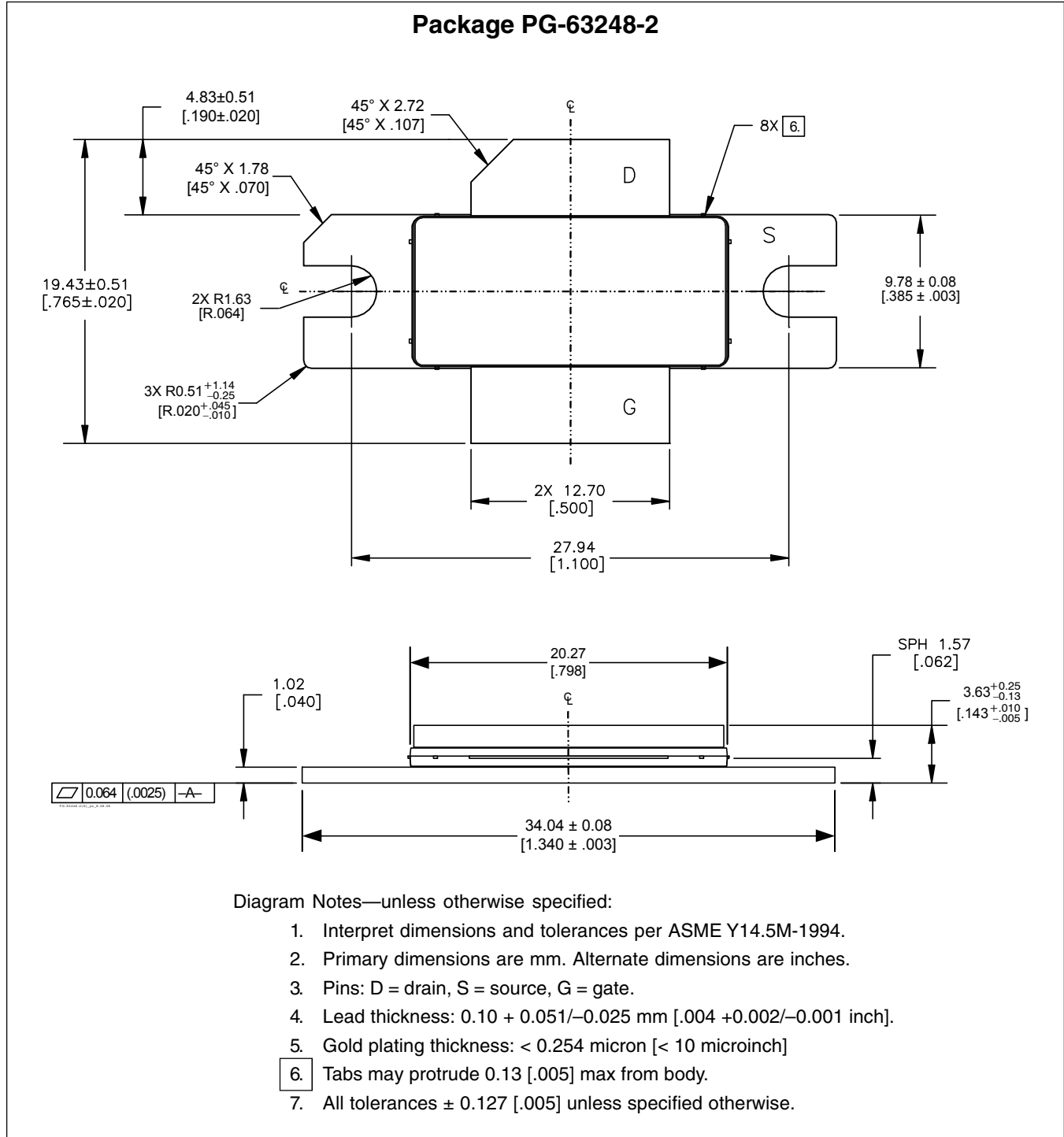

Package Outline Specifications (cont.)

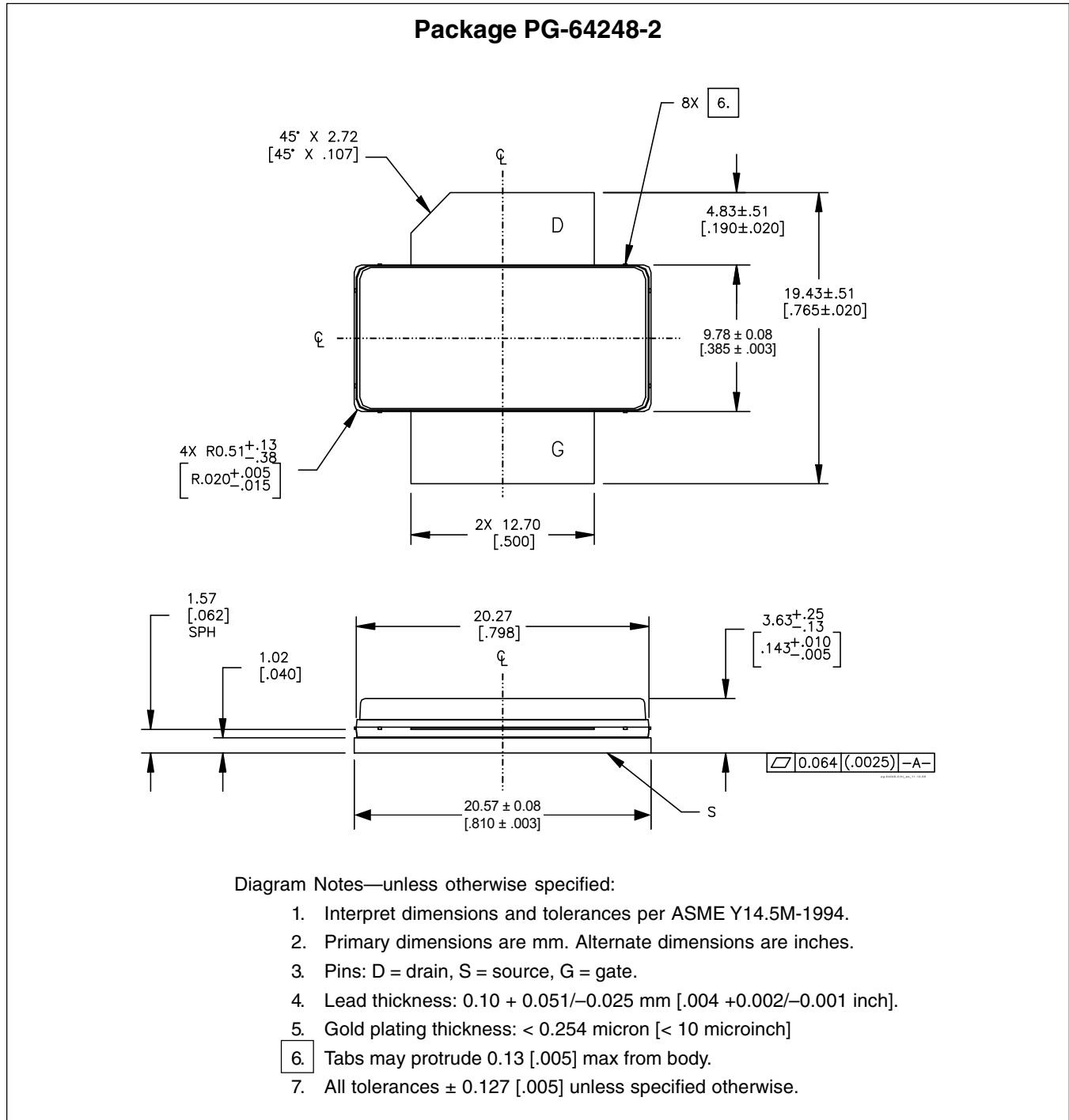

Find the latest and most complete information about products and packaging at the Infineon Internet page <http://www.infineon.com/rfpower>

Revision History: 2009-03-31

Data Sheet

Previous Version: 2008-08-27, Data Sheet

Page	Subjects (major changes since last revision)
8, 9	Update package information

We Listen to Your Comments

Any information within this document that you feel is wrong, unclear or missing at all?

Your feedback will help us to continuously improve the quality of this document.

Please send your proposal (including a reference to this document) to:

highpowerRF@infineon.com

To request other information, contact us at:

+1 877 465 3667 (1-877-GO-LDMOS) USA toll-free

or +1 408 776 0600 International

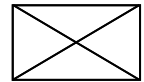
**Edition 2009-03-31****Published by****Infineon Technologies AG****81726 Munich, Germany****© 2009 Infineon Technologies AG****All Rights Reserved.****Legal Disclaimer**

The information given in this document shall in no event be regarded as a guarantee of conditions or characteristics. With respect to any examples or hints given herein, any typical values stated herein and/or any information regarding the application of the device, Infineon Technologies hereby disclaims any and all warranties and liabilities of any kind, including without limitation, warranties of non-infringement of intellectual property rights of any third party.

Information

For further information on technology, delivery terms and conditions and prices, please contact the nearest Infineon Technologies Office (www.infineon.com/rfpower).

Warnings

Due to technical requirements, components may contain dangerous substances. For information on the types in question, please contact the nearest Infineon Technologies Office.

Infineon Technologies components may be used in life-support devices or systems only with the express written approval of Infineon Technologies, if a failure of such components can reasonably be expected to cause the failure of that life-support device or system or to affect the safety or effectiveness of that device or system. Life support devices or systems are intended to be implanted in the human body or to support and/or maintain and sustain and/or protect human life. If they fail, it is reasonable to assume that the health of the user or other persons may be endangered.